





# 06 Beads



















Crystal Beads are very popular and easy to use. They are available in the latest fashion colors, effects and cuts. Used in a variety of applications (beading, sewing, wire work, etc.), they blend perfectly with other Swarovski crystal products. They are available loose and linked (metal bead chains).























## Beads Colors & Effects

## Colors & Effects

### Colors

	Crystal 001
	Black Diamond 215
	Light Azore 361
	Aquamarine 202
	Light Sapphire 211
	Indian Sapphire 217
	Sapphire 206
	Capri Blue 243
	Montana 207
	Chrysole 238
	Peridot 214
	Erinite 360
	Indicolite 379
	Blue Zircon 229
	Emerald 205
	Jonquil 213
	Light Topaz 226
	Khaki 550
	Lime 385

### Effects

	Crystal Boreale 001 AB
	Crystal Boreale Zx 001 ABZ
	Crystal Salin 001 SAT
	Crystal Comet Argent Light 001 CAL
	Crystal Helictrope 001 HEL
	Crystal Silver Shade 001 SHA
	Crystal Matt Finish 001 MAT
	White Opal Sky Blue 234 SBL
	White Opal Star Shine 234 STS
	Crystal Bermuda Blue 001 BBL
	Crystal Helictrope 001 HEL
	Crystal Metallic Blue Zx 001 METBZ
	Crystal Silver Shade 001 SHA
	Crystal Golden Shadow 001 GSHA
	Crystal Copper 001 COP
	Crystal Donado Zx 001 DORZ
	Jet Hermitte 280 HEM
	Jet Hermitte Zx 280 HEMZ
	Jet Nat Zx 280 NUTZ
	Crystal Vitral Medium 001 VM

### Numerical Order

001	Crystal	213	Jonquil	280 HEM	Jet Hermitte
001 AB	Crystal Aurore Boreale	214	Peridot	280 HEMZ	Jet Hermitte Zx
001 ABZ	Crystal Aurore Boreale Zx	215	Black Diamond	280 NUTZ	Jet Nat Zx
001 BBL	Crystal Bermuda Blue	217	Indian Sapphire	281	White Alabaster
001 CAL	Crystal Comet Argent Light	220	Smoked Topaz	293	Rose Alabaster
001 COP	Crystal Copper	221	Light Smoked Topaz	360	Erinite
001 DORZ	Crystal Donado Zx	223	Light Rose	361	Light Azore
001 GSHA	Crystal Golden Shadow	225	Smoky Quartz	362	Light Peach
001 HEL	Crystal Helictrope	226	Light Topaz	371	Violet
001 MAT	Crystal Matt Finish	227	Light Stam	374	Indian Red
001 METBZ	Crystal Metallic Blue Zx	228	Chryse	379	Indicolite
001 SHA	Crystal Silver Shade	229	Blue Zircon	385	Lime
001 SAT	Crystal Salin	234	White Opal	389	Violet Opal
001 VM	Crystal Vitral Medium	234 SBL	White Opal Sky Blue	390	Pacific Opal
202	Aquamarine	234 STS	White Opal Star Shine	391	Silk
203	Topaz	236	Hyacinth	394	Caribbean Blue Opal
204	Amethyst	237	Fresopal	501	Ruby
205	Emerald	238	Chrysole	502	Fuchsia
206	Sapphire	241	Garnet	515	Burgandy
207	Montana	243	Capri Blue	539	Tanzanite
208	Stam	246	Light Colorado Topaz	542	Pedernandacha
209	Rose	267	Turquoise	550	Khaki
211	Light Sapphire	277	Purple Velvet		
212	Light Amethyst	280	Jet		

### Alphabetical Order

Amethyst (204)	Amethyst (237)	Olivine (228)
Aquamarine (202)	Aquamarine (202)	Pacific Opal (390)
Black Diamond (215)	Garnet (241)	Pedernandacha (542)
Blue Zircon (229)	Hyacinth (236)	Peridot (214)
Burgandy (515)	Indian Red (374)	Purple Velvet (277)
Capri Blue (243)	Indian Sapphire (217)	Rose (209)
Caribbean Blue Opal (394)	Indicolite (379)	Rose Alabaster (293)
Chrysole (238)	Jet (280)	Ruby (501)
Crystal (001)	Jet Hermitte (280 HEM)	Sapphire (206)
Crystal Aurore Boreale (001 AB)	Jet Hermitte Zx (280 HEMZ)	Stam (208)
Crystal Aurore Boreale Zx (001 ABZ)	Jet Nat Zx (280 NUTZ)	Silk (391)
Crystal Bermuda Blue (001 BBL)	Jonquil (213)	Smoked Topaz (220)
Crystal Comet Argent Light (001 CAL)	Khaki (550)	Smoky Quartz (225)
Crystal Copper (001 COP)	Light Amethyst (212)	Tanzanite (539)
Crystal Donado Zx (001 DORZ)	Light Azore (361)	Topaz (203)
Crystal Golden Shadow (001 GSHA)	Light Colorado Topaz (246)	Turquoise (267)
Crystal Helictrope (001 HEL)	Light Peach (362)	Violet (371)
Crystal Matt Finish (001 MAT)	Light Rose (223)	Violet Opal (389)
Crystal Metallic Blue Zx (001 METBZ)	Light Sapphire (211)	White Alabaster (281)
Crystal Salin (001 SAT)	Light Stam (227)	White Opal (234)
Crystal Silver Shade (001 SHA)	Light Smoked Topaz (221)	White Opal Sky Blue (234 SBL)
Crystal Vitral Medium (001 VM)	Light Topaz (226)	White Opal Star Shine (234 STS)
Emerald (205)	Lime (385)	
Erinite (360)	Montana (207)	

Classic Colors: This color range offers a wide choice of traditional Swarovski crystal colors.  
Exclusive Colors: This color range is offered exclusively by Swarovski.

Slight changes in shades are unavoidable.

Classic Colors Exclusive Colors

# Beads

## Summary

1 Threaded View  
2 Hole View  
3 Back View

1	2	3		1	2	3	
			<b>5000</b> 3, 4, 5, 6, 7, 8, 10, 12, 14, 16, 18, 20 mm				<b>5305</b> 5, 6 mm
			<b>5003</b> 6, 8, 10, 12, 14, 16 mm				<b>5308</b> 6, 8 mm
			<b>5015</b> 3, 4 mm				<b>5309/1</b> 4, 6, 8 mm
			<b>5020</b> 3, 4, 6, 8 mm				<b>5310</b> 4.5, 5.5 mm
			<b>5025</b> 4, 6, 8 mm				<b>5400</b> 6.6x6, 8x7, 9x8 mm
			<b>5040</b> 6, 8 mm				<b>5500</b> 9x6, 10.5x7, 12x8, 18x12 mm
			<b>5100</b> 5, 6, 8 mm				<b>5523</b> 12, 16 mm
			<b>5200</b> 6x4, 7.5x5, 9x6, 10.5x7, 12x8 mm				<b>5600</b> 4, 6, 8 mm
			<b>5203</b> 12x8, 18x12 mm				<b>5601</b> 4, 6, 8, 10, 12 mm
			<b>5205</b> 15x6 mm				<b>5744</b> 5, 6, 8 mm
			<b>5301</b> 3, 4, 5, 6, 8, 10 mm				<b>5754</b> 5, 6, 8 mm

# Beads

## 5000

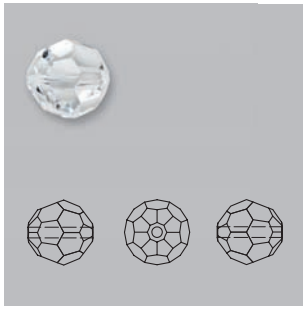

Size	3 mm	4 mm	5 mm	6 mm	7 mm	8 mm	10 mm	12 mm	14 mm	16 mm	18 mm	20 mm
------	------	------	------	------	------	------	-------	-------	-------	-------	-------	-------

### Color of Stone

Crystal (001)	■	■	■	■	■	■	■	■	■	■	■	■
Crystal AB (001 AB)	■	■	■	■	■	■	■	■	■	■	■	■
Crystal Copper (001 COP)	■	■	■	■	■	■	■	■	■	■	■	■
Crystal Dorado (001 DOR)	■	■	■	■	■	■	■	■	■	■	■	■
Crystal Dorado 2x (001 DOR2)	■	■	■	■	■	■	■	■	■	■	■	■
Crystal Golden Shadow (001 GSHA)	■	■	■	■	■	■	■	■	■	■	■	■
Crystal Metallic Blue (001 METBL)	■	■	■	■	■	■	■	■	■	■	■	■
Crystal Satin (001 SAT)	■	■	■	■	■	■	■	■	■	■	■	■
Crystal Silver Shade (001 SSHA)	■	■	■	■	■	■	■	■	■	■	■	■
Crystal Vitrail Medium (001 VM)	■	■	■	■	■	■	■	■	■	■	■	■
Jet (280)	■	■	■	■	■	■	■	■	■	■	■	■
Jet AB (280 AB)	■	■	■	■	■	■	■	■	■	■	■	■
Jet Hematite (280 HEM)	■	■	■	■	■	■	■	■	■	■	■	■
Jet Hematite 2x (280 HEM2)	■	■	■	■	■	■	■	■	■	■	■	■
Jet Nut (280 NUT)	■	■	■	■	■	■	■	■	■	■	■	■
Jet Nut 2x (280 NUT2)	■	■	■	■	■	■	■	■	■	■	■	■
Amethyst (204)	■	■	■	■	■	■	■	■	■	■	■	■
Amethyst AB (204 AB)	■	■	■	■	■	■	■	■	■	■	■	■
Aquamarine (202)	■	■	■	■	■	■	■	■	■	■	■	■
Aquamarine AB (202 AB)	■	■	■	■	■	■	■	■	■	■	■	■
Black Diamond (215)	■	■	■	■	■	■	■	■	■	■	■	■
Black Diamond AB (215 AB)	■	■	■	■	■	■	■	■	■	■	■	■
Blue Zircon (229)	■	■	■	■	■	■	■	■	■	■	■	■
Blue Zircon AB (229 AB)	■	■	■	■	■	■	■	■	■	■	■	■
Burgundy (515)	■	■	■	■	■	■	■	■	■	■	■	■
Burgundy AB (515 AB)	■	■	■	■	■	■	■	■	■	■	■	■
Capri Blue (243)	■	■	■	■	■	■	■	■	■	■	■	■
Capri Blue AB (243 AB)	■	■	■	■	■	■	■	■	■	■	■	■
Caribbean Blue Opal (394)	■	■	■	■	■	■	■	■	■	■	■	■
Chrysolite (238)	■	■	■	■	■	■	■	■	■	■	■	■
Chrysolite AB (238 AB)	■	■	■	■	■	■	■	■	■	■	■	■
Emerald (205)	■	■	■	■	■	■	■	■	■	■	■	■
Emerald AB (205 AB)	■	■	■	■	■	■	■	■	■	■	■	■
Erinite (360)	■	■	■	■	■	■	■	■	■	■	■	■
Erinite AB (360 AB)	■	■	■	■	■	■	■	■	■	■	■	■
Fireopal (237)	■	■	■	■	■	■	■	■	■	■	■	■
Fireopal AB (237 AB)	■	■	■	■	■	■	■	■	■	■	■	■
Fuchsia (502)	■	■	■	■	■	■	■	■	■	■	■	■
Fuchsia AB (502 AB)	■	■	■	■	■	■	■	■	■	■	■	■
Garnet (241)	■	■	■	■	■	■	■	■	■	■	■	■
Garnet AB (241 AB)	■	■	■	■	■	■	■	■	■	■	■	■

06 Beads

# Beads

5000		Size	3 mm	4 mm	5 mm	6 mm	7 mm	8 mm	10 mm
Color of Stone									
	Hyacinth (236)		■			■		■	
	Hyacinth AB (236 AB)		■			■		■	
	Indian Red (374)		■			■		■	
	Indian Red AB (374 AB)		■			■		■	
	Indian Sapphire (217)		■			■		■	
	Indian Sapphire AB (217 AB)		■			■		■	
	Indicolite (379)		■	■		■		■	
	Indicolite AB (379 AB)		■	■		■		■	
	Jonquil (213)		■	■	■	■	■	■	■
	Jonquil AB (213 AB)		■	■	■	■	■	■	■
	Khaki (550)	New!	■	■		■		■	
	Light Amethyst (212)		■	■	■	■	■	■	■
	Light Amethyst AB (212 AB)		■	■	■	■	■	■	■
	Light Azore (361)		■	■		■		■	
	Light Azore AB (361 AB)		■	■		■		■	
	Light Colorado Topaz (246)		■	■	■	■	■	■	■
	Light Colorado Topaz AB (246 AB)		■	■	■	■	■	■	■
	Light Peach (362)		■	■		■		■	
	Light Peach AB (362 AB)		■	■		■		■	
	Light Rose (223)		■	■	■	■	■	■	■
	Light Rose AB (223 AB)		■	■	■	■	■	■	■
	Light Sapphire (211)		■	■	■	■	■	■	■
	Light Sapphire AB (211 AB)		■	■	■	■	■	■	■
	Light Siam (227)		■	■	■	■	■	■	■
	Light Siam AB (227 AB)		■	■	■	■	■	■	■
	Light Smoked Topaz (221)		■	■		■		■	
	Light Smoked Topaz AB (221 AB)		■	■		■		■	
	Light Topaz (226)		■	■		■		■	
	Light Topaz AB (226 AB)		■	■		■		■	
	Lime (385)		■	■		■		■	
	Lime AB (385 AB)		■	■		■		■	
	Montana (207)		■	■	■	■	■	■	■
	Montana AB (207 AB)		■	■	■	■	■	■	■
	Olivine (228)		■	■	■	■	■	■	■
	Olivine AB (228 AB)		■	■	■	■	■	■	■
	Pacific Opal (390)		■	■		■		■	
	Padparadscha (542)		■	■		■		■	
	Padparadscha AB (542 AB)		■	■		■		■	
	Peridot (214)		■	■	■	■	■	■	■
	Peridot AB (214 AB)		■	■	■	■	■	■	■
	Purple Velvet (277)	New!	■	■		■		■	
	Rose (209)		■	■	■	■	■	■	■

# Beads

Beads  
06

5000		Size	3 mm	4 mm	5 mm	6 mm	7 mm	8 mm	10 mm
Color of Stone		Rose AB (209 AB)	■	■	■	■	■	■	■
Rose Alabaster (293)	■	■	■	■	■	■	■	■	
Sapphire (206)	■	■	■	■	■	■	■	■	
Sapphire AB (206 AB)	■	■	■	■	■	■	■	■	
Siam (208)	■	■	■	■	■	■	■	■	
Siam AB (208 AB)	■	■	■	■	■	■	■	■	
Silk (391)	■	■	■	■	■	■	■	■	
Smoked Topaz (220)	■	■	■	■	■	■	■	■	
Smoked Topaz AB (220 AB)	■	■	■	■	■	■	■	■	
Tanzanite (539)	■	■	■	■	■	■	■	■	
Tanzanite AB (539 AB)	■	■	■	■	■	■	■	■	
Topaz (203)	■	■	■	■	■	■	■	■	
Topaz AB (203 AB)	■	■	■	■	■	■	■	■	
Turquoise (267)	■	■	■	■	■	■	■	■	
Turquoise AB (267 AB)	■	■	■	■	■	■	■	■	
Violet (371)	■	■	■	■	■	■	■	■	
Violet AB (371 AB)	■	■	■	■	■	■	■	■	
Violet Opal (389)	■	■	■	■	■	■	■	■	
White Alabaster (281)	■	■	■	■	■	■	■	■	
White Opal (234)	■	■	■	■	■	■	■	■	
White Opal AB (234 AB)	■	■	■	■	■	■	■	■	
White Opal Sky Blue (234 SBL)	■	■	■	■	■	■	■	■	
White Opal Star Shine (234 STS)	■	■	■	■	■	■	■	■	

5003		Size	6 mm	8 mm	10 mm	12 mm	14 mm	16 mm
Color of Stone		Crystal (001)	■	■	■	■	■	■
Crystal AB (001 AB)	■	■	■	■	■	■	■	■

# Beads

## 5015

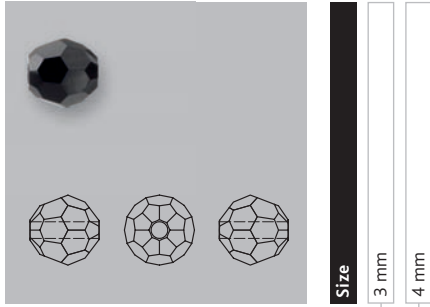

### Color of Stone

- Jet (280)
- Jet Hematite 2x (280 HEM2)

## 5020 Helix Bead

New Article

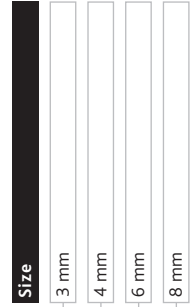
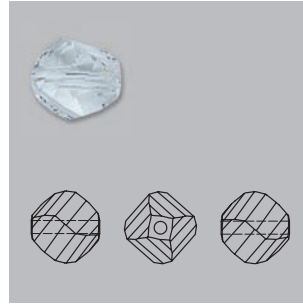

### Color of Stone

- Crystal (001)
- Crystal AB (001 AB)
- Crystal Golden Shadow (001 GSHA) New!
- Crystal Silver Shade (001 SSHA) New!
- Jet (280)
- Aquamarine (202)
- Black Diamond (215)
- Light Rose (223)
- Peridot (214)
- Purple Velvet (277) New!
- Siam (208)
- Silk (391) New!
- Topaz (203)

## 5025

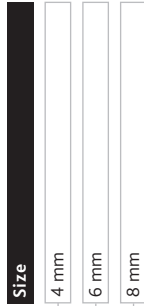
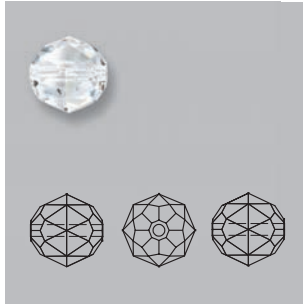

### Color of Stone

- Crystal (001)
- Crystal AB (001 AB)
- Jet (280)
- Amethyst (204)
- Aquamarine (202)
- Black Diamond (215)
- Burgundy (515)
- Erinite (360)
- Light Amethyst (212)
- Light Colorado Topaz (246)
- Light Rose (223)
- Light Sapphire (211)
- Light Smoked Topaz (221)
- Lime (385)
- Montana (207)
- Rose (209)
- Siam (208)
- Smoky Quartz (225)
- Tanzanite (539)
- Violet (371)
- White Opal (234)

# Beads

## 5040

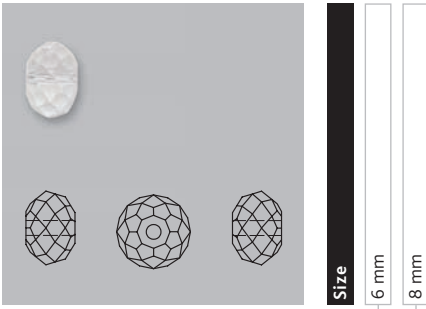

Color of Stone		6 mm	8 mm
Crystal (001)		■	■
Crystal AB (001 AB)		■	■
Crystal Copper (001 COP)	New!	■	■
Crystal Golden Shadow (001 GSHA)	New!	■	■
Crystal Silver Shade (001 SSHA)	New!	■	■
Jet (280)		■	■
Amethyst (204)		■	■
Aquamarine (202)		■	■
Black Diamond (215)		■	■
Caribbean Blue Opal (394)	New!	■	■
Erinite (360)		■	■
Indicolite (379)	New!	■	■
Jonquil (213)		■	■
Khaki (550)	New!	■	■
Light Colorado Topaz (246)		■	■
Light Rose (223)		■	■
Pacific Opal (390)		■	■
Padparadscha (542)		■	■
Purple Velvet (277)	New!	■	■
Rose Alabaster (293)		■	■
Siam (208)		■	■
Silk (391)	New!	■	■
Tanzanite (539)		■	■
Topaz (203)		■	■
Violet Opal (389)		■	■
White Alabaster (281)		■	■
White Opal (234)		■	■

## 5100

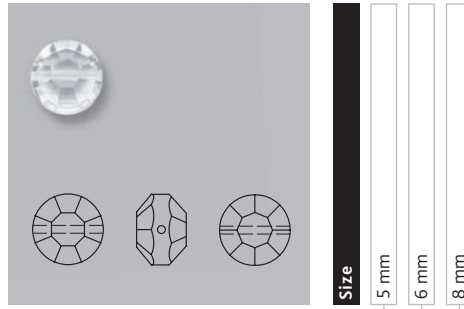

Color of Stone		5 mm	6 mm	8 mm
Crystal (001)		■	■	■
Crystal AB (001 AB)		■	■	■

Beads 06

# Beads

## 5200

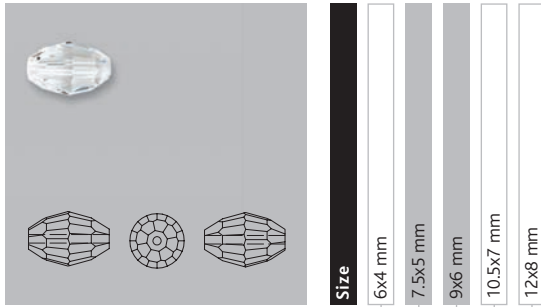

Color of Stone		6x4 mm	7.5x5 mm	9x6 mm	10.5x7 mm	12x8 mm
Crystal (001)		■	■	■	■	■
Crystal AB (001 AB)		■	■	■	■	■
Jet (280)		■	■	■		
Jet Hematite 2x (280 HEM2)		■	■	■		
Amethyst (204)				■		
Aquamarine (202)				■		
Black Diamond (215)				■		
Fuchsia (502)				■		
Light Colorado Topaz (246)				■		
Peridot (214)				■		
Rose (209)				■		
Siam (208)				■		
Tanzanite (539)				■		
Topaz (203)				■		
White Opal (234)				■		

## 5203 Polygon Bead

New Article

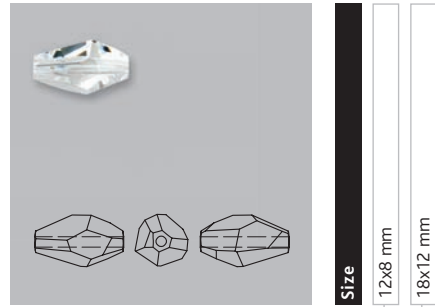

Color of Stone		12x8 mm	18x12 mm
Crystal (001)		■	■
Crystal AB (001 AB)		■	■
Crystal Copper (001 COP)	New	■	■
Crystal Golden Shadow (001 GSHA)	New	■	■
Crystal Matt Finish (001 MAT)		■	■
Jet (280)		■	■
Amethyst (204)		■	■
Aquamarine (202)		■	■
Black Diamond (215)		■	■
Light Colorado Topaz (246)		■	■
Olivine (228)		■	■
Padparadscha (542)		■	■
Siam (208)		■	■
Smoked Topaz (220)		■	■

## 5205

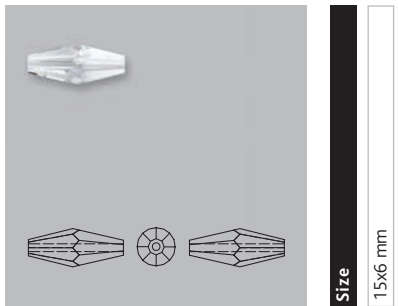

Color of Stone		15x6 mm
Crystal (001)		■
Crystal AB (001 AB)		■
Crystal Copper (001 COP)	New	■
Crystal Golden Shadow (001 GSHA)	New	■
Crystal Silver Shade (001 SSHA)	New	■
Jet (280)		■
Amethyst (204)		■
Aquamarine (202)		■
Light Amethyst (212)		■
Light Siam (227)		■
Peridot (214)		■
Sapphire (206)		■
Topaz (203)		■

# Beads

## 5301

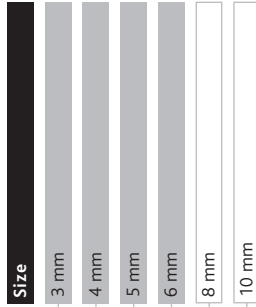
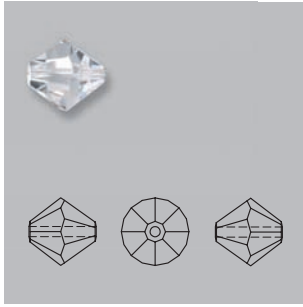

### Color of Stone

Crystal (001)	■	■	■	■	■	■
Crystal AB (001 AB)	■	■	■	■	■	■
Crystal AB 2x (001 AB2)	■	■	■	■	■	■
Crystal AB Satin (001 ABSAT)	■	■	■	■	■	■
Crystal CAL (001 CAL)	■	■	■	■	■	■
Crystal Copper (001 COP)	■	■	■	■	■	■
Crystal Dorado 2x (001 DOR2)	■	■	■	■	■	■
Crystal Golden Shadow (001 GSHA)	■	■	■	■	■	■
Crystal Heliotrope (001 HEL)	■	■	■	■	■	■
Crystal Metallic Blue 2x (001 METB2)	■	■	■	■	■	■
Crystal Satin (001 SAT)	■	■	■	■	■	■
Crystal Silver Shade (001 SSHA)	■	■	■	■	■	■
Crystal Vitrail Medium (001 VM)	■	■	■	■	■	■
Jet (280)	■	■	■	■	■	■
Jet AB (280 AB)	■	■	■	■	■	■
Jet AB 2x (280 AB2)	■	■	■	■	■	■
Jet Hematite (280 HEM)	■	■	■	■	■	■
Jet Hematite 2x (280 HEM2)	■	■	■	■	■	■
Jet Nut 2x (280 NUT2)	■	■	■	■	■	■
Amethyst (204)	■	■	■	■	■	■
Amethyst AB (204 AB)	■	■	■	■	■	■
Amethyst AB 2x (204 AB2)	■	■	■	■	■	■
Amethyst Satin (204 SAT)	■	■	■	■	■	■
Aquamarine (202)	■	■	■	■	■	■
Aquamarine AB (202 AB)	■	■	■	■	■	■
Aquamarine AB 2x (202 AB2)	■	■	■	■	■	■
Aquamarine Satin (202 SAT)	■	■	■	■	■	■
Black Diamond (215)	■	■	■	■	■	■
Black Diamond AB (215 AB)	■	■	■	■	■	■
Black Diamond AB 2x (215 AB2)	■	■	■	■	■	■
Black Diamond Satin (215 SAT)	■	■	■	■	■	■
Blue Zircon (229)	■	■	■	■	■	■
Blue Zircon AB (229 AB)	■	■	■	■	■	■
Blue Zircon AB 2x (229 AB2)	■	■	■	■	■	■
Blue Zircon Satin (229 SAT)	■	■	■	■	■	■
Burgundy (515)	■	■	■	■	■	■
Burgundy AB (515 AB)	■	■	■	■	■	■
Burgundy Satin (515 SAT)	■	■	■	■	■	■
Capri Blue (243)	■	■	■	■	■	■
Capri Blue AB (243 AB)	■	■	■	■	■	■
Capri Blue AB 2x (243 AB2)	■	■	■	■	■	■

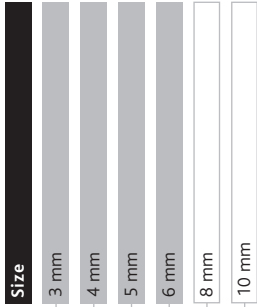

### Color of Stone

Capri Blue Satin (243 SAT)	■	■	■	■	■	■
Caribbean Blue Opal (394)	■	■	■	■	■	■
Chrysolite (238)	■	■	■	■	■	■
Chrysolite AB (238 AB)	■	■	■	■	■	■
Chrysolite Satin (238 SAT)	■	■	■	■	■	■
Emerald (205)	■	■	■	■	■	■
Emerald AB (205 AB)	■	■	■	■	■	■
Emerald AB 2x (205 AB2)	■	■	■	■	■	■
Emerald Satin (205 SAT)	■	■	■	■	■	■
Erinite (360)	■	■	■	■	■	■
Erinite AB (360 AB)	■	■	■	■	■	■
Erinite Satin (360 SAT)	■	■	■	■	■	■
Fireopal (237)	■	■	■	■	■	■
Fireopal AB (237 AB)	■	■	■	■	■	■
Fuchsia (502)	■	■	■	■	■	■
Fuchsia AB (502 AB)	■	■	■	■	■	■
Fuchsia AB 2x (502 AB2)	■	■	■	■	■	■
Fuchsia Satin (502 SAT)	■	■	■	■	■	■
Garnet (241)	■	■	■	■	■	■
Garnet AB (241 AB)	■	■	■	■	■	■
Garnet AB 2x (241 AB2)	■	■	■	■	■	■
Garnet Satin (241 SAT)	■	■	■	■	■	■
Hyacinth (236)	■	■	■	■	■	■
Hyacinth AB (236 AB)	■	■	■	■	■	■
Hyacinth AB 2x (236 AB2)	■	■	■	■	■	■
Hyacinth Satin (236 SAT)	■	■	■	■	■	■
Indian Red (374)	■	■	■	■	■	■
Indian Red AB (374 AB)	■	■	■	■	■	■
Indian Red Satin (374 SAT)	■	■	■	■	■	■
Indian Sapphire (217)	■	■	■	■	■	■
Indian Sapphire AB (217 AB)	■	■	■	■	■	■
Indian Sapphire Satin (217 SAT)	■	■	■	■	■	■
Indicolite (379)	■	■	■	■	■	■
Indicolite AB (379 AB)	■	■	■	■	■	■
Indicolite Satin (379 SAT)	■	■	■	■	■	■
Jonquil (213)	■	■	■	■	■	■
Jonquil AB (213 AB)	■	■	■	■	■	■
Jonquil AB 2x (213 AB2)	■	■	■	■	■	■
Jonquil Satin (213 SAT)	■	■	■	■	■	■
Khaki (550)	■	■	■	■	■	■
Light Amethyst (212)	■	■	■	■	■	■
Light Amethyst AB (212 AB)	■	■	■	■	■	■

# Beads

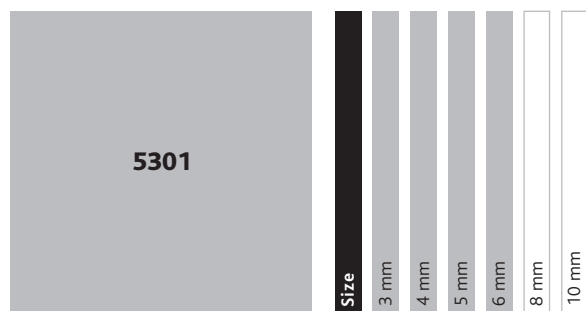

Color of Stone	3 mm	4 mm	5 mm	6 mm	8 mm	10 mm
Light Amethyst AB 2x (212 AB2)						
Light Amethyst Satin (212 SAT)						
Light Azure (361)						
Light Azure AB (361 AB)						
Light Azure AB 2x (361 AB2)						
Light Azure Satin (361 SAT)						
Light Colorado Topaz (246)						
Light Colorado Topaz AB (246 AB)						
Light Colorado Topaz AB 2x (246 AB2)						
Light Colorado Topaz Satin (246 SAT)						
Light Peach (362)						
Light Peach AB (362 AB)						
Light Peach AB 2x (362 AB2)						
Light Peach Satin (362 SAT)						
Light Rose (223)						
Light Rose AB (223 AB)						
Light Rose AB 2x (223 AB2)						
Light Rose Satin (223 SAT)						
Light Sapphire (211)						
Light Sapphire AB (211 AB)						
Light Sapphire AB 2x (211 AB2)						
Light Sapphire Satin (211 SAT)						
Light Siam (227)						
Light Siam AB (227 AB)						
Light Siam AB 2x (227 AB2)						
Light Siam Satin (227 SAT)						
Light Smoked Topaz (221)						
Light Smoked Topaz AB (221 AB)						
Light Smoked Topaz Satin (221 SAT)						
Light Topaz (226)						
Light Topaz AB (226 AB)						
Light Topaz Satin (226 SAT)						
Lime (385)						
Lime AB (385 AB)						
Lime Satin (385 SAT)						
Montana (207)						
Montana AB (207 AB)						
Montana AB 2x (207 AB2)						
Montana Satin (207 SAT)						
Olivine (228)						
Olivine AB (228 AB)						
Olivine AB 2x (228 AB2)						

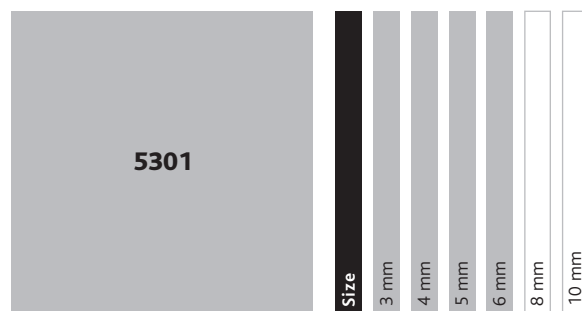

Color of Stone	3 mm	4 mm	5 mm	6 mm	8 mm	10 mm
Olivine Satin (228 SAT)						
Pacific Opal (390)						
Padparadscha (542)						
Padparadscha AB (542 AB)						
Padparadscha AB 2x (542 AB2)						
Padparadscha Satin (542 SAT)						
Peridot (214)						
Peridot AB (214 AB)						
Peridot AB 2x (214 AB2)						
Peridot Satin (214 SAT)						
Purple Velvet (277)						
Rose (209)						
Rose AB (209 AB)						
Rose AB 2x (209 AB2)						
Rose Satin (209 SAT)						
Rose Alabaster (293)						
Rose Alabaster AB (293 AB)						
Rose Alabaster Satin (293 SAT)						
Ruby (501)						
Ruby AB (501 AB)						
Ruby Satin (501 SAT)						
Sapphire (206)						
Sapphire AB (206 AB)						
Sapphire AB 2x (206 AB2)						
Sapphire Satin (206 SAT)						
Siam (208)						
Siam AB (208 AB)						
Siam AB 2x (208 AB2)						
Siam Satin (208 SAT)						
Silk (391)						
Smoked Topaz (220)						
Smoked Topaz AB (220 AB)						
Smoked Topaz AB 2x (220 AB2)						
Smoked Topaz Satin (220 SAT)						
Smoky Quartz (225)						
Smoky Quartz AB (225 AB)						
Smoky Quartz Satin (225 SAT)						
Tanzanite (539)						
Tanzanite AB (539 AB)						
Tanzanite AB 2x (539 AB2)						
Tanzanite Satin (539 SAT)						
Topaz (203)						

# Beads

06 Beads

5301		Size					
		3 mm	4 mm	5 mm	6 mm	8 mm	10 mm
Color of Stone							
Topaz AB (203 AB)		■	■	■	■		
Topaz AB 2x (203 AB2)			■				
Topaz Satin (203 SAT)		■	■	■	■		
Turquoise (267)		■	■	■	■		
Turquoise AB (267 AB)		■	■	■	■		
Turquoise AB 2x (267 AB2)			■				
Turquoise Satin (267 SAT)			■				
Violet (371)		■	■	■	■	■	■
Violet AB (371 AB)		■	■		■		
Violet AB 2x (371 AB2)			■				
Violet Satin (371 SAT)			■		■		
Violet Opal (389)		■	■	■	■		
White Alabaster (281)		■	■	■	■		
White Alabaster AB (281 AB)			■				
White Alabaster Satin (281 SAT)			■				
White Opal (234)		■	■	■	■	■	■
White Opal AB (234 AB)		■	■		■		
White Opal AB 2x (234 AB2)			■				
White Opal Satin (234 SAT)			■				
White Opal Sky Blue (234 SBL)			■				
White Opal Star Shine (234 STS)			■				

## 5305

5305		Size	
		5 mm	6 mm
Color of Stone			
Crystal (001)		■	■
Crystal AB (001 AB)		■	■
Jet (280)		■	■
Light Colorado Topaz (246)		■	■
Peridot (214)		■	■
Rose (209)		■	■
Sapphire (206)		■	■
Siam (208)		■	■
Topaz (203)		■	■

## 5308

5308		Size	
		6 mm	8 mm
Color of Stone			
Crystal (001)		■	■
Crystal AB (001 AB)		■	■

# Beads

## 5309/1

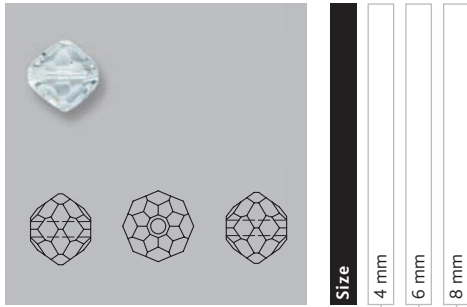

### Color of Stone

Crystal (001)	4 mm	6 mm	8 mm
Crystal AB (001 AB)	4 mm	6 mm	8 mm
Crystal Cosmojet (001 COS)	4 mm	6 mm	8 mm

## 5400

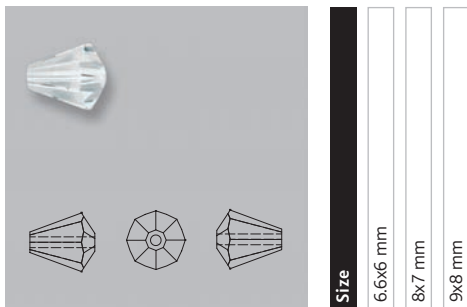

### Color of Stone

Crystal (001)	6.6x6 mm	8x7 mm	9x8 mm
Crystal AB (001 AB)	6.6x6 mm	8x7 mm	9x8 mm
Jet (280)	6.6x6 mm	8x7 mm	9x8 mm
Emerald (205)	6.6x6 mm	8x7 mm	9x8 mm
Emerald AB (205 AB)	6.6x6 mm	8x7 mm	9x8 mm
Fuchsia (502)	6.6x6 mm	8x7 mm	9x8 mm
Fuchsia AB (502 AB)	6.6x6 mm	8x7 mm	9x8 mm
Light Colorado Topaz (246)	6.6x6 mm	8x7 mm	9x8 mm
Siam (208)	6.6x6 mm	8x7 mm	9x8 mm

## 5310 Simplicity Bead

New Article

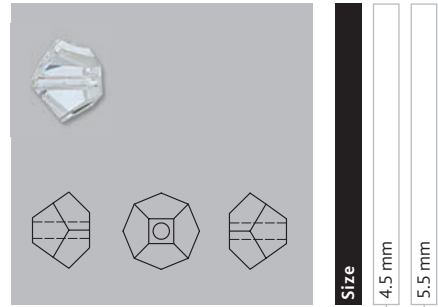

### Color of Stone

Crystal (001)	4.5 mm	5.5 mm
Crystal AB (001 AB)	4.5 mm	5.5 mm
Crystal Copper (001 COP) <small>New</small>	4.5 mm	5.5 mm
Crystal Golden Shadow (001 GSHA) <small>New</small>	4.5 mm	5.5 mm
Crystal Silver Shade (001 SSHHA) <small>New</small>	4.5 mm	5.5 mm
Jet (280)	4.5 mm	5.5 mm
Aquamarine (202)	4.5 mm	5.5 mm
Black Diamond (215)	4.5 mm	5.5 mm
Jonquil (213)	4.5 mm	5.5 mm
Khaki (550) <small>New</small>	4.5 mm	5.5 mm
Light Rose (223)	4.5 mm	5.5 mm
Peridot (214)	4.5 mm	5.5 mm
Siam (208)	4.5 mm	5.5 mm
Topaz (203)	4.5 mm	5.5 mm
Violet (371)	4.5 mm	5.5 mm
White Opal (234)	4.5 mm	5.5 mm

# Beads

06 Beads

## 5500

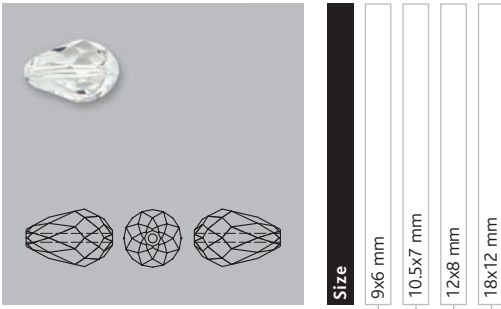

Color of Stone		9x6 mm	10.5x7 mm	12x8 mm	18x12 mm
Crystal (001)		■	■	■	■
Crystal AB (001 AB)		■	■	■	■
Jet (280)		■			
Amethyst (204)		■			
Aquamarine (202)		■			
Black Diamond (215)		■			
Indicolite (379)		■			
Light Azore (361)		■			
Light Colorado Topaz (246)		■			
Padparadscha (542)		■			
Peridot (214)		■			
Rose (209)		■			
Siam (208)		■			
Tanzanite (539)		■			
Topaz (203)		■			
White Opal (234)		■			

## 5523 Cosmic Bead

New Article

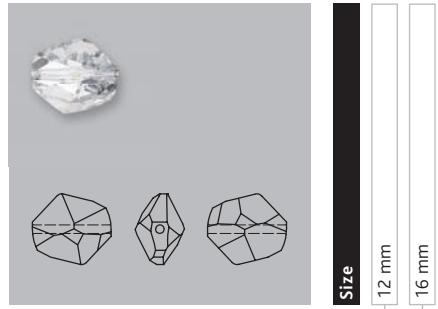

Color of Stone		12 mm	16 mm
Crystal (001)		■	■
Crystal AB (001 AB)		■	■
Crystal Copper (001 COP)	<small>New!</small>	■	■
Crystal Golden Shadow (001 GSHA)	<small>New!</small>	■	■
Crystal Silver Shade (001 SSHA)	<small>New!</small>	■	■
Jet (280)		■	■
Amethyst (204)		■	
Aquamarine (202)		■	
Fuchsia (502)		■	■
Indicolite (379)		■	■
Light Amethyst (212)		■	■
Olivine (228)		■	■

## 5600

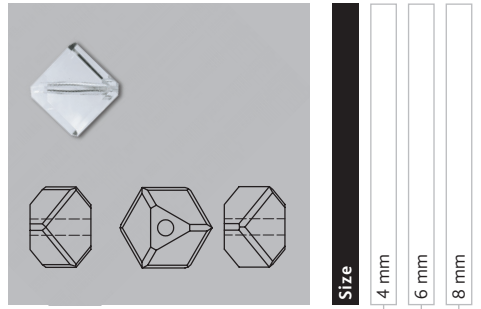

Color of Stone		4 mm	6 mm	8 mm
Crystal (001)		■	■	■
Crystal AB B (001 ABB)		■	■	■
Crystal Golden Shadow (001 GSHAB)	<small>New!</small>	■	■	■
Jet (280)		■	■	■
Aquamarine (202)		■	■	■
Black Diamond (215)		■	■	■
Fuchsia (502)		■	■	■
Light Colorado Topaz (246)		■	■	■
Light Rose (223)		■	■	■
Light Siam (227)		■	■	■
Olivine (228)		■	■	■
Peridot (214)		■	■	■
Tanzanite (539)		■	■	■
White Alabaster (281)		■	■	■

# Beads

## 5601

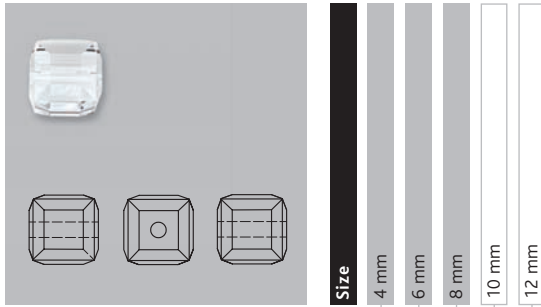

### Color of Stone

Color of Stone	4 mm	6 mm	8 mm	10 mm	12 mm
Crystal (001)	■	■	■	■	■
Crystal AB B (001 ABB)	■	■	■	■	■
Crystal Copper B (001 COPB)	■	■	■	■	■
Crystal Golden Shadow B (001 GSHAB)	■	■	■	■	■
Crystal Silver Shade B (001 SSHAB)	■	■	■	■	■
Crystal Vitrail Medium B (001 VMB)	■	■	■	■	■
Jet (280)	■	■	■	■	■
Amethyst (204)	■	■	■	■	■
Amethyst AB B (204 ABB)	■	■	■	■	■
Aquamarine (202)	■	■	■	■	■
Aquamarine AB B (202 ABB)	■	■	■	■	■
Black Diamond (215)	■	■	■	■	■
Caribbean Blue Opal (394)	■	■	■	■	■
Chrysolite (238)	■	■	■	■	■
Fuchsia (502)	■	■	■	■	■
Fuchsia AB B (502 ABB)	■	■	■	■	■
Khaki (550)	■	■	■	■	■
Light Amethyst (212)	■	■	■	■	■
Light Colorado Topaz (246)	■	■	■	■	■
Light Rose (223)	■	■	■	■	■
Light Rose AB B (223 ABB)	■	■	■	■	■
Light Sapphire (211)	■	■	■	■	■
Light Sapphire AB B (211 ABB)	■	■	■	■	■
Light Topaz (226)	■	■	■	■	■
Pacific Opal (390)	■	■	■	■	■
Padparadscha (542)	■	■	■	■	■
Peridot (214)	■	■	■	■	■
Peridot AB B (214 ABB)	■	■	■	■	■
Purple Velvet (277)	■	■	■	■	■
Rose (209)	■	■	■	■	■
Rose AB B (209 ABB)	■	■	■	■	■
Rose Alabaster (293)	■	■	■	■	■
Sapphire (206)	■	■	■	■	■
Siam (208)	■	■	■	■	■
Siam AB B (208 ABB)	■	■	■	■	■
Silk (391)	■	■	■	■	■
Tanzanite (539)	■	■	■	■	■
Tanzanite AB B (539 ABB)	■	■	■	■	■
Topaz (203)	■	■	■	■	■
Turquoise (267)	■	■	■	■	■
Violet Opal (389)	■	■	■	■	■
White Alabaster (281)	■	■	■	■	■

## 5744 Flower Bead

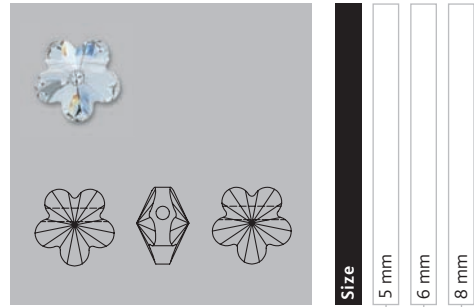

### Color of Stone

Color of Stone	5 mm	6 mm	8 mm
Crystal (001)	■	■	■
Crystal AB (001 AB)	■	■	■
Aquamarine (202)	■	■	■
Fuchsia (502)	■	■	■
Jonquil (213)	■	■	■
Light Rose (223)	■	■	■
Light Siam (227)	■	■	■
Peridot (214)	■	■	■
Violet (371)	■	■	■

## 5754 Butterfly Bead

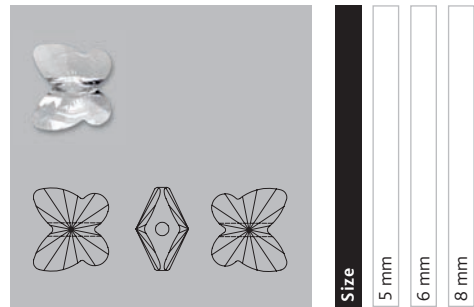

### Color of Stone

Color of Stone	5 mm	6 mm	8 mm
Crystal (001)	■	■	■
Crystal AB (001 AB)	■	■	■
Aquamarine (202)	■	■	■
Fuchsia (502)	■	■	■
Jonquil (213)	■	■	■
Light Rose (223)	■	■	■
Light Siam (227)	■	■	■
Peridot (214)	■	■	■
Violet (371)	■	■	■

# Beads

## Product Details

Article Size	Packing Unit = Minimum Order Quantity in Pieces	Base Quantity Unit for Special Productions of Effects in Pieces	Base Quantity Unit for Special Productions of Effects in Packs	Average Net Weight in Gram per Packing Unit Crystal (001)	Average Gross Weight in Gram per Packing Unit Crystal (001)
<b>5000</b>					
3 mm	1,440	4,320	3	56.40	67.27
4 mm	1,440	2,880	2	127.80	138.67
5 mm	720	1,440	2	125.75	136.62
6 mm	360	1,080	3	97.50	108.37
7 mm	288	864	3	150.80	183.68
8 mm	288	864	3	206.90	238.54
10 mm	144	432	3	168.48	189.09
12 mm	72	288	4	172.22	194.17
14 mm	72	288	4	295.20	328.62
16 mm	48	192	4	301.39	345.71
18 mm	24	168	7	201.60	218.76
20 mm	12	84	7	147.60	166.97
<b>5003</b>					
6 mm	360	1,080	3	131.28	142.15
8 mm	288	864	3	239.80	266.12
10 mm	144	432	3	234.06	257.38
12 mm	72	288	4	189.40	210.10
14 mm	48	240	5	205.92	226.63
16 mm	48	192	4	321.60	341.92
<b>5015</b>					
3 mm	1,440	4,320	3	50.03	60.90
4 mm	1,440	2,880	2	133.60	144.47
<b>5020</b>					
3 mm	1,440	4,320	4	45.00	55.87
4 mm	1,440	2,880	2	108.50	119.37
6 mm	360	1,440	4	89.00	99.87
8 mm	288	864	3	175.20	206.84
<b>5025</b>					
4 mm	1,440	2,880	2	111.30	122.17
6 mm	360	1,440	4	88.40	99.27
8 mm	288	576	2	218.60	244.92
<b>5040</b>					
6 mm	360	1,080	3	85.80	96.67
8 mm	288	864	3	162.00	189.95
<b>5100</b>					
5 mm	720	1,440	2	120.75	131.62
6 mm	360	1,080	3	91.95	102.82
8 mm	288	864	3	175.07	195.23
<b>5200</b>					
6x4 mm	720	720	1	105.30	116.17
7.5x5 mm	360	1,080	3	95.60	106.47
9x6 mm	144	576	4	67.80	78.67
10.5x7 mm	288	576	2	235.20	262.76
12x8 mm	144	432	3	174.07	197.78

# Beads

## Product Details

Article Size	Packing Unit = Minimum Order Quantity in Pieces	Base Quantity Unit for Special Productions of Effects in Pieces	Base Quantity Unit for Special Productions of Effects in Packs	Average Net Weight in Gram per Packing Unit Crystal (001)	Average Gross Weight in Gram per Packing Unit Crystal (001)
<b>5203</b>					
12x8 mm	144	864	6	98.80	122.24
18x12 mm	72	288	4	181.44	207.42
<b>5205</b>					
15x6 mm	288	288	1	170.74	204.53
<b>5301</b>					
3 mm	1,440	5,760	4	45.27	56.14
4 mm	1,440	4,320	3	95.00	105.87
5 mm	720	2,880	4	106.70	117.57
6 mm	360	1,800	5	88.06	98.93
8 mm	288	864	3	169.39	201.03
10 mm	144	576	4	182.20	205.84
<b>5305</b>					
5 mm	720	1,440	2	63.00	73.87
6 mm	360	1,080	3	60.38	71.25
<b>5308</b>					
6 mm	360	1,080	3	65.05	75.92
8 mm	288	576	2	109.40	136.01
<b>5309/1</b>					
4 mm	1,440	2,880	2	118.30	129.17
6 mm	360	1,440	4	100.50	111.37
8 mm	288	576	2	198.72	218.88
<b>5310</b>					
4.5 mm	720	2,880	4	67.30	78.10
5.5 mm	360	1,080	3	72.00	82.89
<b>5400</b>					
6.6x6 mm	360	1,080	3	96.80	107.67
8x7 mm	144	576	4	61.90	72.77
9x8 mm	144	576	4	99.66	110.53
<b>5500</b>					
9x6 mm	144	576	4	70.44	81.31
10.5x7 mm	288	576	2	212.15	239.71
12x8 mm	144	288	2	171.99	192.15
18x12 mm	72	144	2	260.64	282.59
<b>5523</b>					
12 mm	144	288	2	171.10	201.40
16 mm	72	144	2	194.30	225.10
<b>5600</b>					
4 mm	288	1,440	5	52.82	74.08
6 mm	288	864	3	188.80	208.82
8 mm	288	288	1	459.07	486.86

# Beads

## Product Details

Article Size	Packing Unit = Minimum Order Quantity in Pieces	Base Quantity Unit for Special Productions of Effects in Pieces	Base Quantity Unit for Special Productions of Effects in Packs	Average Net Weight in Gram per Packing Unit Crystal (001)	Average Gross Weight in Gram per Packing Unit Crystal (001)
<b>5601</b>					
4 mm	288	1,440	5	52.48	73.74
6 mm	288	864	3	168.68	188.70
8 mm	288	288	1	372.10	401.13
10 mm	144	288	2	329.76	353.08
12 mm	72	144	2	309.60	330.31
<b>5744</b>					
5 mm	720	1,440	2	92.00	102.87
6 mm	360	1,080	3	56.60	67.47
8 mm	288	576	2	95.83	127.81
<b>5754</b>					
5 mm	720	1,440	2	75.40	86.27
6 mm	360	720	2	50.50	61.37
8 mm	288	576	2	93.05	125.03

